

SPECIAL NOTE

Lamps are set for 7" W.C. pressure on natural gas & 11" W.C. pressure for LP gas.

FOR YOUR SAFETY

If you smell gas:

1. Shut off gas to the appliance.
2. Extinguish any open flame.
3. If odor continues, immediately call your gas supplier.

FOR YOUR SAFETY

Do not place combustible materials near this appliance. Do not store or use gasoline or other flammable vapors and liquids in the vicinity of this or any other appliance.

THESE INSTRUCTIONS SHOULD BE LEFT WITH THE CONSUMER.

KEEP THESE INSTRUCTIONS FOR FUTURE REFERENCE.

The installation of this gas lamp must conform with all local codes or, in the absence of local codes, with the latest edition of the National Fuel Gas Code, ANSI Z223.1

ITEM	PART NO.	DESCRIPTION
1.	WKA-1A	Cast Aluminum Finial
2.	LSU	Bronze top screen, 4-3/8" dia.
3.*	DIB	Dual inverted cast aluminum Burner Manifold
4*	BT-1	Ceramic mantle tip. Accepts No. 2 ring size mantles, hard or soft
5.*	MTL-2	Twin pack of soft inverted mantles No. 2 ring size
6.*	BTA	Burner tube assembly: vertical tube, air mixer and adjustable air shutter
7.*	ORF	Valve orifice. Specify LP or natural gas
8.	WBX	Burner extender
9.	LSL	Bronze lower screen 3-5/8" x 4-5/8"
10.*	GLV	Valve, includes orifice. Specify LP or natural gas
11.	GLS-1	Tempered glass pane. Resists thermal shock of heat or cold

*12. DMI Complete lamp burner kit. Includes valve with orifice (specify LP or natural gas), mixer tube with adjustable air shutter, burner head, ceramic tips and two mantles.

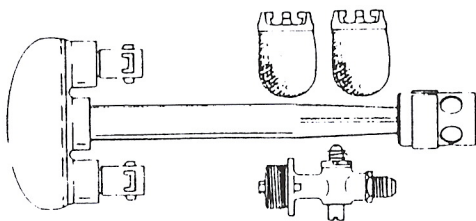

MODERN HOME PRODUCTS

From The People That Pioneered Gas BBQ Grills & Gas Yard Lamps

GAS LAMP MODEL WK

PARTS, INSTALLATION and MAINTENANCE

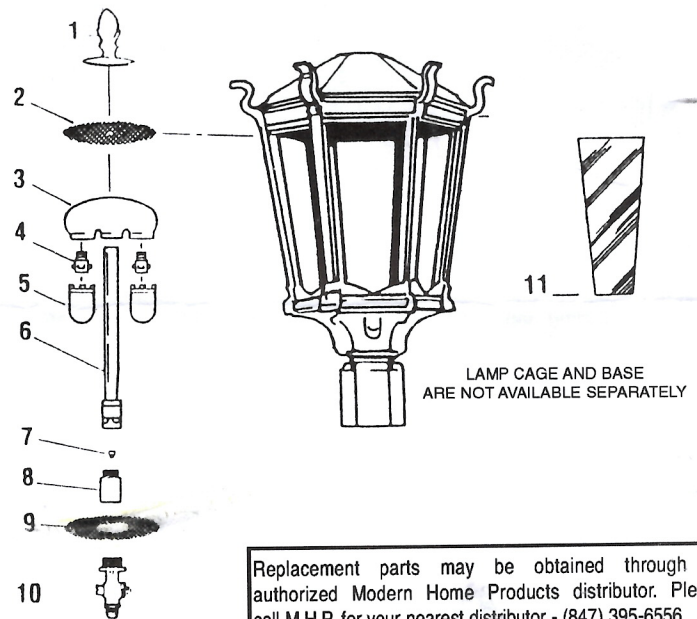

Replacement parts may be obtained through an authorized Modern Home Products distributor. Please call M.H.P. for your nearest distributor - (847) 395-6556.

NOTE: In Canada, the installation shall be in accordance with: the current edition of CAN/CGA-B149.1 Natural gas installation code or CAN/CGA-B149.2 Propane gas installation code, and all local codes where applicable.

POST & TUBING INFORMATION

Proper post and tubing selection is essential. Your local gas company or an authorized MHP Distributor can supply these parts. 1/4" soft copper tubing that has been internally tinned is recommended. 1/4" flare nuts should be used on both ends.

NOTE: The lamp is for outdoor installation only and must be installed at least 12" in any direction from any combustible materials.

POST INSTALLATION

1. Dig a hole in the ground approximately 12" wide by 24" deep.
2. Set the bottom of the post in the center of the hole. Brace the post in a plumb position and pour concrete around the post to just below the level of the gas line access hole.

INSTALL LAMP ON POST

1. If not already furnished, place tubing in post. Tubing should have at least two coils at the top of the post.
2. Connect gas supply line to tubing at the base of the post and tighten flare nuts clockwise. No sealants are necessary.
3. Perform any remaining assembly to the lamp but do not install glass.
 - Install finial
 - Remove valve and burner assembly from inside the lamp by

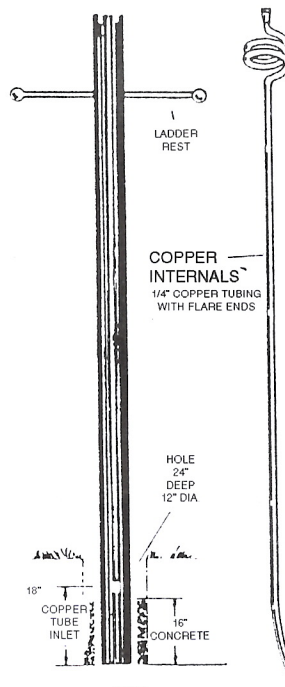

inserting a screwdriver through the air holes at the base of the burner tube. Turn counter clockwise while holding the valve to keep it from turning. **IMPORTANT: ORIFICE SHOULD BE THREADED INTO THE BURNER TUBE EXTENDER (WBX) NOT INTO THE VALVE.**

• Attach valve to gas supply tubing and tighten flare nuts clockwise. Be sure the fittings are tight.

Slowly lower the lamp onto the post, guiding the valve up through the center hole in the bottom of the lamp. Take care not to bend or crimp the tubing.

Align slot in the top of the post with the access hole in the collar. Align valve stem with the access hole and tighten the lock screw in the collar of the lamp to secure the lamp to the post.

Before threading the burner tube and extender onto the valve **make sure the orifice is in the extender, NOT in the valve. NO ORIFICE SHOULD BE IN THE VALVE.** Thread the burner tube onto the valve.

Keep the valve from turning by inserting a screwdriver through the access hole.

Be certain the lamp valve is in the off position before turning on the gas supply.

Leaving lamp valve in off position, turn on main gas supply and check all connections for leaks using a soapy solution. Tighten any leaky joints and recheck for leaks.

LIGHTING INSTRUCTIONS INVERTED BURNER

IMPORTANT: Gas mantles are very delicate and should not be handled roughly.

- Remove new mantle from the container without touching the cloth portion. Hang the mantle on the burner tip, rotating it to fit into the slots on the burner tip.
- Nothing should touch the cloth portion**, so when lighting, do not touch the match to the mantle itself. (Pull down only on a soft mantle to shape it.)

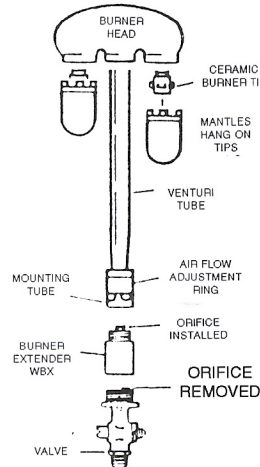

- If a mantle should become damaged, additional mantles may be obtained through your local gas company, gas appliance dealer or hardware store. Always replace both mantles at the same time. Mantles are Modern Home Products' Part No. MTL-2, No. 2 ring size. These are soft mantles requiring reshaping.

D. Refer to steps 1 - 6 for proper lighting procedure.

- To clean the glass panels of your lamp, turn the gas off with a screwdriver through the access hole in the lower collar of the lamp. Allow the lamp to cool, remove the glass and wash it. Glass panels may be placed in a dishwasher.

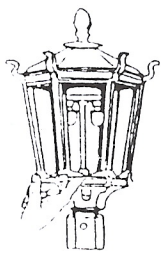

STEP 1

Remove the glass by lifting from the bottom with fore finger, pulling out slightly, and lowering. **NOTE: Proper combustion is essential. Do not obstruct air inlet or outlet vents.**

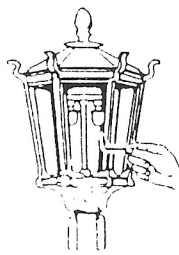

STEP 2

WITH GAS TURNED OFF, hold a lighted match up to but not touching the mantle. This will burn off the protective coating (and it will flash slightly). Do not touch the mantle with the match.

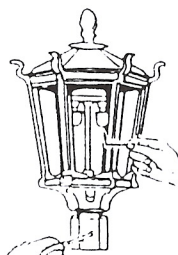

STEP 3

After the mantles have stopped burning, use a screwdriver to slowly turn the gas ON and hold another match up to, but not touching, the mantles to light them. When lit, turn the gas on full.



STEP 4

Your Modern Home lamp is factory set to burn at its most efficient point. However, this adjustment may be changed during shipment. To adjust this, raise or lower the air shutter until the mantles are burning their brightest.

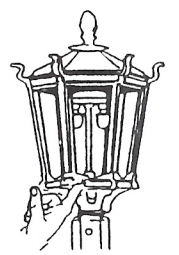

STEP 6

Replace the glass by fitting the top edge into the frame top, holding the glass against the tabs inside the frame. Allow the glass to slide into frame bottom.

STEP 5
If flame extends above the ceramic mantle ring, turn off lamp valve and contact your local gas company or authorized MHP distributor.
NOTE: Proper combustion is essential. Do not obstruct air inlet or outlet vents.



MAINTENANCE INSTRUCTIONS

1. Monthly visually inspect the lamps burner flame characteristics. The flame should be contained inside the mantle sack, (Fig. 1) and not extend above the ceramic mantle ring, (Fig. 2). If flame extends above the mantle ring, turn lamp OFF and contact your local gas company or authorized MHP distributor.
2. Proper combustion is essential. Do not obstruct air inlet or outlet vents.
3. Always keep the appliance area clear and free of combustible material, gasoline and other flammable liquids.
4. Turn gas OFF and let lamp cool before performing any maintenance. Periodically remove glass panels and clean with hot soapy water or glass cleaner. Lamp may be repainted with a good quality heat resistant paint after roughing surface with steel wool or sandpaper.

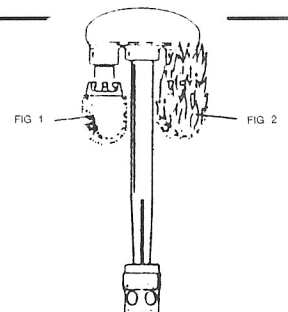

Everglow

FOR MODELS WK & VK Lamp Burner Assembly for Natural Gas ONLY

*Follow these instructions carefully for proper operation of the MHP Gas Lamp being used on NATURAL GAS.

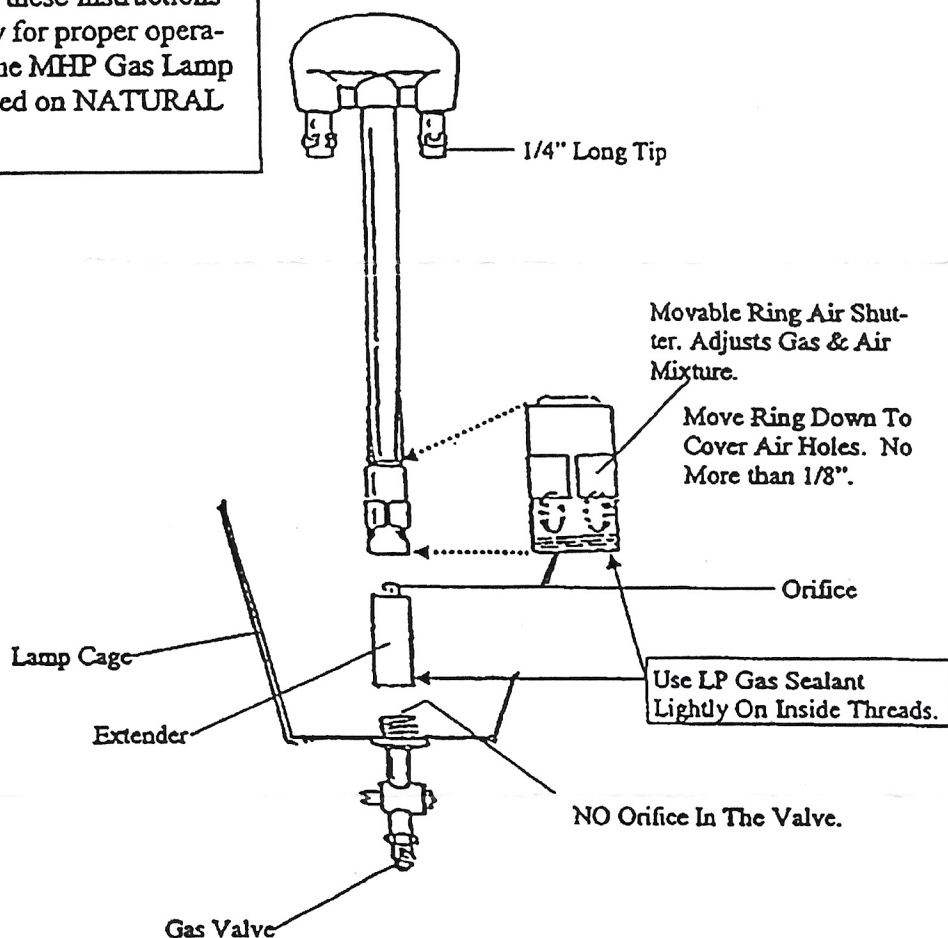

**Modern
Home Products**
Corporation

150 South Ram Road, Antioch, IL 60002 Phone: (847) 395-6556 Fax: (847) 395-9121